

ICOM

BIT5 1200
Compatible

INSTRUCTION MANUAL

VHF TRANSCEIVER

IC-F51

UHF TRANSCEIVER

IC-F61

CE 0081  II 2G
EE x ib IIA T3



Icom Inc.

FOREWORD

READ ALL INSTRUCTIONS carefully and completely before using the transceiver.

SAVE THIS INSTRUCTION MANUAL— This instruction manual contains important operating instructions for the IC-F51 VHF TRANSCEIVER and IC-F61 UHF TRANSCEIVER.

EXPLICIT DEFINITIONS

WORD	DEFINITION
⚠ WARNING	Personal injury, fire hazard or electric shock may occur.
CAUTION	Equipment damage may occur.
NOTE	If disregarded, inconvenience only. No risk of personal injury, fire or electric shock.

OPERATING NOTES

- When transmitting with a portable radio, hold the radio in a vertical position with its microphone 5 to 10 centimeters away from your mouth. Keep the antenna at least 2.5 centimeters from your head and body.
- If you wear a portable two-way radio on your body, ensure that the antenna is at least 2.5 centimeters from your body when transmitting.

PRECAUTIONS

⚠ WARNING! NEVER hold the transceiver so that the antenna is very close to, or touching exposed parts of the body, especially the face or eyes, while transmitting. The transceiver will perform best if the microphone is 5 to 10 cm away from the lips and the transceiver is vertical.

⚠ WARNING! NEVER operate the transceiver with a headset or other audio accessories at high volume levels.

CAUTION! NEVER short the terminals of the battery pack.

NEVER connect the transceiver to a power source other than the BP-227AX. Such a connection will ruin the transceiver.

NEVER use non-Icom battery packs/chargers to prevent the loss of the transceiver's good performance and warranty.

DO NOT push the PTT when not actually desiring to transmit.

DO NOT use or place the transceiver in direct sunlight or in areas with temperatures below -20°C or above $+55^{\circ}\text{C}$.

The basic operations, transmission and reception of the transceiver, are guaranteed within the specified operating temperature range (depending on version). However, the LCD display may be operate correctly, or show an indication in the case of long hours of operation, or after being placed in extremely cold areas.

DO NOT modify the transceiver for any reason.

MAKE SURE the flexible antenna and battery pack are securely attached to the transceiver, and that the antenna and battery pack are dry before attachment. Exposing the inside of the transceiver to water will result in serious damage to the transceiver.

Icom optional equipment is designed for optimal performance when used with this transceiver. We are not responsible for the transceiver being damaged or any accident caused when using non-Icom optional equipment.

TABLE OF CONTENTS

FOREWORD	i
EXPLICIT DEFINITIONS	i
OPERATING NOTES	i
PRECAUTIONS	ii
TABLE OF CONTENTS	iii
SUPPLIED ACCESSORIES	iv
INTRINSIC SAFETY	v
1 ACCESSORIES	1-3
■ Accessory attachments	1
2 PANEL DESCRIPTION	4-12
■ Front, top and side panels	4
■ Function display	7
■ Programmable function keys	8
3 CONVENTIONAL OPERATION	13-19
■ Turning power ON	13
■ Channel selection	13
■ Call procedure	14
■ Receiving and transmitting	15
■ Scrambler function	18
■ User set mode	19
4 BIIS OPERATION	20-35
■ Default setting	20
■ Receiving a call	21
■ Transmitting a call	24
■ Receiving a message	27
■ Transmitting a status	30
■ Transmitting an SDM	31
■ Position data transmission	32
■ Printer connection	33
■ PC connection	33
■ Digital ANI	33

■ Auto emergency transmission	34
■ Stun function.....	34
■ BIIS indication	35
■ Priority A channel selection	35
5 BATTERY CHARGING	36–42
■ Battery charging	36
■ Caution	37
■ Optional battery chargers	38
6 SPEAKER-MICROPHONE	43–44
■ Optional HM-138 description	43
■ Attachment	44
7 OPTIONS	45
8 ATEX CAUTIONS	46–47
9 DOC	48

SUPPLIED ACCESSORIES

The following accessories are supplied: Qty.

- Flexible antenna 1
- Battery pack 1
- Jack cover 1 set
- Belt clip 1 set
- Function name stickers* (KEY-STICKER) 1

*There are no names on the programmable function keys since the functions can be freely assigned to [P0] to [P3], [Red], [▼] and [▲] keys.

Attach the supplied function name stickers above the appropriate keys for easy recognition of that key's assigned function.

INTRINSIC SAFETY



Versions of the IC-F51/F61 which display the “EX” marking on the serial number seal.

The approval rating for these models is II2G EEx ib IIA T3.

WARNING! NEVER charge the BP-227AX (with/without the transceiver) in an explosive atmosphere. The optional battery chargers are not approved as Intrinsically Safe.

When the transceiver is used in a hazardous area, the BP-227AX **MUST** be attached, either the jack cover or HM-138 **MUST** be attached to the speaker-microphone connector.

KEEP the transceiver and the BP-227AX clean to avoid any risk of ignition due to the build-up of electrostatic charges.

Repair of Icom radios should only be carried out by authorized Icom distributors. In particular, repair of ATEX approved radios can **ONLY** be done by Icom to maintain the intrinsically safe rating. **NEVER** attempt to repair an ATEX approved radio. Only Icom has the repair expertise and procedures to maintain the ATEX approval. Contact your Icom distributor or authorised dealer for details.

The ATEX standard is described on the 94/9/EC sticker (Ex Marking) and BP-227AX as below.

The following illustrations are show for the IC-F51/F61.

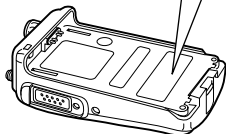
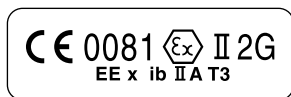
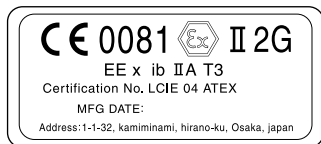

BP-227AX

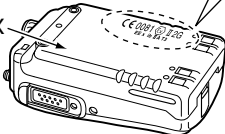

■ Accessory attachments

◇ Flexible antenna

Connect the supplied flexible antenna to the antenna connector.

CAUTION!

- **NEVER HOLD** by the antenna when carrying the transceiver.
- Transmitting without an antenna may damage the transceiver.

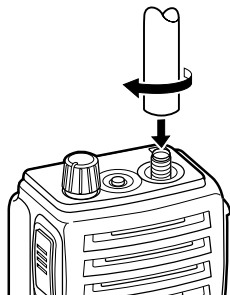

◇ Jack cover

Attach the jack cover when the optional speaker-microphone is not used.

When the transceiver is used in a hazardous areas, either the jack cover or HM-138 must be attached to the connector. Failure to do this will make the radio ATEX non-compliant and may result in an accident during use in hazardous areas.

To attach the jack cover:

- 1 Insert the jack cover into the [SP MIC] connector.
- 2 Tighten the screw.

To detach the jack cover:

- 1 Unscrew the screw with a phillips screwdriver.
- 2 Detach the jack cover for the speaker-microphone connection.

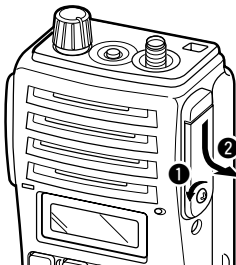
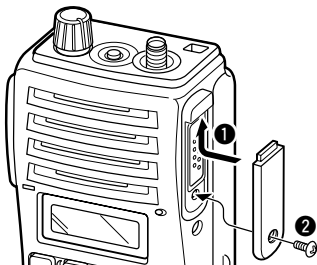

◇ Battery pack

To attach the battery pack:

Slide the battery pack on the back of the transceiver in the direction of the arrow (①), then lock it with the battery release button.

- Slide the battery pack until the battery release button makes a 'click' sound.

To release the battery pack:

Push the battery release button in the direction of the arrow (②) as shown below. The battery pack is then released.

/// **NEVER** release or attach the battery pack when the transceiver is wet or soiled. This may result in water or dust getting into the transceiver/battery pack and may damage the transceiver.

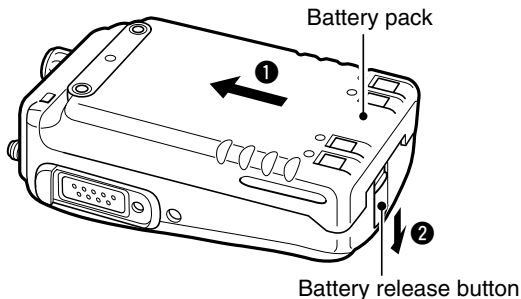

◆ Belt clip

Attach the belt clip to the back of the transceiver with the supplied screws.

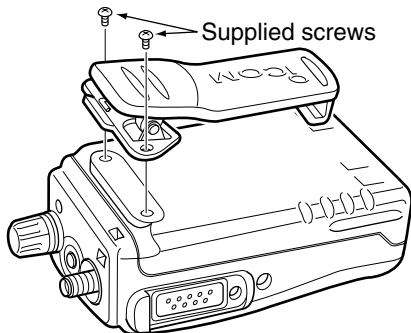

2 PANEL DESCRIPTION

■ Front, top and side panels

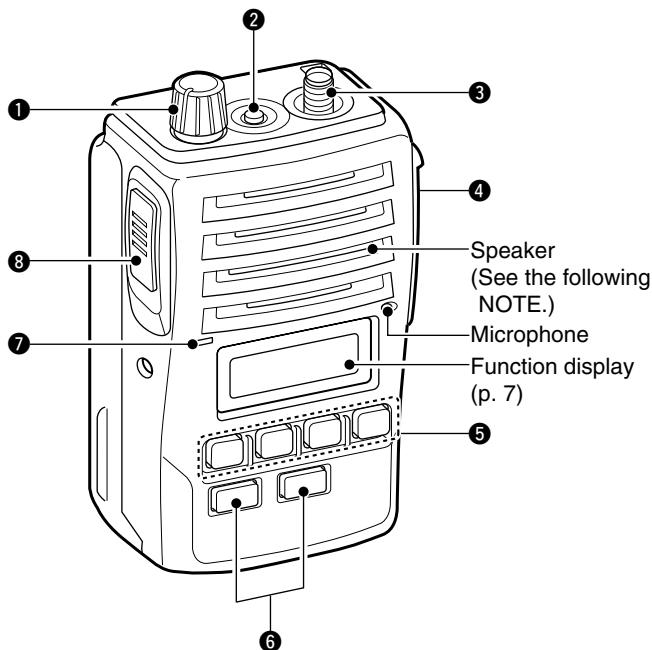

NOTE: If the speaker netting (for dust proofing) becomes wet, dry it with a hair drier (cool mode) etc. before operating the transceiver. Otherwise the audio may be difficult to hear for loss of the sound pressure.

1 VOLUME CONTROL [VOL]

Turns power ON and adjusts the audio level.

2 RED BUTTON

The desired function can be assigned by your dealer.

3 ANTENNA CONNECTOR

Connects the supplied antenna.

4 SPEAKER-MICROPHONE CONNECTOR [SP MIC]

Connects the optional speaker-microphone. (p. 44)

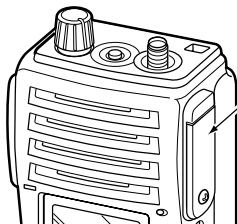

[SP MIC] jack cover

NOTE: KEEP the [SP MIC] jack cover attached to the transceiver when the speaker-microphone is not used.
(See p. 1 for details)

5 DEALER-PROGRAMMABLE KEYS [P0] to [P3]

The desired functions can be assigned independently by your dealer.

6 CH UP AND DOWN KEYS [▲]/[▼]

- ➔ During standby condition, push to select an operating channel.
- ➔ After pushing [TX Code CH Select], push to select a TX code channel.
- ➔ After pushing [DTMF Autodial], push to select a DTMF channel.
- ➔ After pushing and holding [Scan A Start/Stop]/[Scan B Start/Stop], push to select a scan group.
- ➔ After pushing [Digital], push to select a BIIS code, status number or SDM.

*Desired functions can be assigned independently by your dealer.

➔ Continue to the next page.

2 PANEL DESCRIPTION

■ Front, top and side panels (Continued)

⑦ **TRANSMIT/BUSY INDICATOR**

Lights red while transmitting; lights green while receiving a signal, or when the squelch is open.

⑧ **PTT SWITCH [PTT]**

Push and hold to transmit; release to receive.

■ Function display

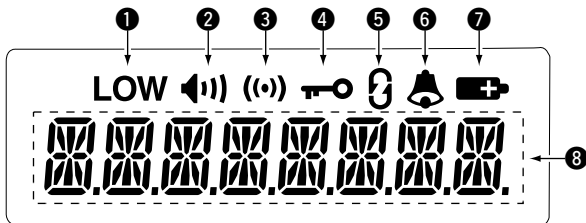

- ① OUTPUT POWER INDICATOR**
Appears when Low 2 or Low 1 is selected.
- ② AUDIBLE INDICATOR**

 - Appears when the channel is in the 'audible' (unmute) condition.
 - Appears when the specified 5-tone/BIIS code is received.
- ③ COMPANDER INDICATOR**
Appears when the compander function is activated.
- ④ KEY LOCK INDICATOR**
Appears during the key lock function ON.
- ⑤ SCRAMBLER INDICATOR**
Appears when the voice scrambler function is activated.
- ⑥ BELL INDICATOR**
Appears/Blinks when the specific 5-tone/BIIS code is received, according to the programming.
- ⑦ BATTERY INDICATOR**
Appears or blinks when the battery power decreases to a specified level.
- ⑧ ALPHANUMERIC DISPLAY**
Displays the operating channel number, channel names, Set mode contents, DTMF numbers, etc.

■ Programmable function keys

The following functions can be assigned to [P0], [P1], [P2], [P3], [Red], [▼] and [▲] programmable function keys.

Consult your Icom dealer or system operator for details concerning your transceivers programming.

If the programmable function names are bracketed in the following explanations, the specific switch used to activate the function depends on programming.

CH UP AND DOWN KEYS

- Select an operating channel.
- Select a transmit code channel after pushing the [TX Code CH Select] keys.
- Select a DTMF channel after pushing the [DTMF Autodial] key.
- Select a scan group after pushing and holding the [Scan A Start/Stop]/[Scan B Start/Stop] keys.
- Select a BISS code, status number or SDM after pushing the [Digital] key.

BANK SELECT KEY

Push this key, then push [CH Up] or [CH Down] to select the desired bank.

SCAN START/STOP KEYS

- Push this key to start scanning; and push again to stop.
- Push and hold this key to indicate the scan group, then select the desired scan group using [CH Up]/[CH Down].

SCAN TAG KEY

Adds or deletes the selected channel to the scan group.

PRIORITY CHANNEL KEYS

- Push to select Priority A or Priority B channel.
- Push and hold [Prio A (Rewrite)] to rewrite the Prio A channel.

MR-CH 1/2/3/4 KEYS

Select an operating channel directly.

MONITOR KEY

Activates one of (or two of) the following functions on each channel independently:

- Push and hold to un-mute the channel (audio is emitted; 'Audible' condition).
- Push to mute the channel (sets to 'Inaudible' only).
- Push to un-mute the channel (sets to 'Audible' only).
- Push after the communication is finished to send a 'reset code'.

 **NOTE:** The un-mute condition ('Audible' condition) may automatically return to the mute condition ('Inaudible' condition) after a specified period.

LOCK KEY

Push and hold to electronically lock all programmable keys except the following:

[Call] (incl. Call A and Call B), [Moni(Audi)] and [Emergency] keys.

OUTPUT POWER SELECTION KEY

Select the transmit output power temporarily or permanently, depending on the pre-setting.

- Ask your dealer for the output power level for each selection.

2 PANEL DESCRIPTION

C.TONE CHANNEL ENTER KEY

Select the continuous tone channel using [CH Up]/[CH Down] keys to change the tone frequency/code setting after pushing this key for permanent operation.

TALK AROUND KEY

Turn the talk around function ON and OFF.

- The talk around function equalizes the transmit frequency to the receive frequency for transceiver-to-transceiver communication.

WIDE/NARROW KEY

Push to toggle the IF bandwidth between wide and narrow.

- The wide passband width can be selected from 25.0 or 20.0 kHz using the CS-F50 CLONING SOFTWARE. Ask your dealer for details.

DTMF AUTODIAL KEY

- Push to enter the DTMF channel selection mode. Then select the desired DTMF channel using [CH Up]/[CH Down] keys.
- After selecting the desired DTMF channel, push this key to transmit the DTMF code.

DTMF RE-DIAL KEY

Push to transmit the last-transmitted DTMF code.

CALL KEYS

Push to transmit a 5-tone/BIIS ID code.

- Call transmission is necessary before you call another station depending on your signalling system.
- The [Call A] and/or [Call B] keys may be available when your system employs selective 'Individual/Group' calls. Ask your dealer which call is assigned to each key.

EMERGENCY KEYS

- Push and hold to transmit an emergency call.
- When [Emergency Single (Silent)] or [Emergency Repeat (Silent)] is pushed, an emergency call is transmitted without a beep emission and LCD indication change.
 - If you want to cancel the emergency call, push (or push and hold) the key again before transmitting the call.
 - The emergency call is transmitted one time only or repeatedly until receiving a control code depending on the pre-setting.

TX CODE ENTER KEY

Push to enter the direct ID code edit mode, for both 5-tone and MSK. Then set the desired digit using [CH Up]/[CH Down]/[TX Code CH Up]/[TX Code CH Down]. (p. 17)

TX CODE CHANNEL SELECT KEY

- Push to enter the direct ID code channel selection mode. Then set the desired channel using [CH Up]/[CH Down]/[TX Code CH Up]/[TX Code CH Down]. (p. 16)
- While in ID code channel selection mode, push for 1 sec. to enter the ID code edit mode. Then set the desired digit using [CH Up]/[CH Down]/[TX Code CH Up]/[TX Code CH Down]. (p. 17)

TX CODE CHANNEL UP/DOWN KEYS

Push to select a TX code channel directly.

ID MEMORY READ KEY

- Recalls detected ID codes.
 - Push this key, then push [CH Up]/[CH Down] for selection.
 - Up to 5 ID's are memorized.
- Push and hold to erase the selected memorized ID's.

2 PANEL DESCRIPTION

VOICE SCRAMBLER FUNCTION

Push to toggle the voice scrambler function ON and OFF.

COMPANDER KEY

Push to toggle the compander function ON and OFF.

The compander function reduces noise components from the transmitting audio to provide clear communication.

USER SET MODE KEY

- Push and hold to enter user set mode.
 - During user set mode, push this key to select an item, and push [CH Up]/[CH Down] to change the value or condition.
- Push and hold this key again to exit user set mode.
 - User set mode is also available via the 'Power ON function'. Please refer to p. 19 also.

DIGITAL KEY (BIIS operation only)

- Push to select the call ID list, transmit message and standby condition. Toggles between queue channel and received message record indication after queue channel is selected.
- Push and hold to select queue channel indication.

STATUS UP/DOWN KEYS (BIIS operation only)

- While in the standby condition, push to display the transmit status indication and select a status number.
- When a received SDM is displayed, push to cancel the automatic scroll and scroll the message manually.
- When an SDM that contains more than 8 characters is displayed, push to scroll the message manually.

CONVENTIONAL OPERATION 3

■ Turning power ON

- ① Rotate [VOL] to turn power ON.
- ② If the transceiver is programmed for a start up passcode, input digit codes as directed by your dealer.
 - The keys in the table below can be used for password input:
 - The transceiver detects numbers in the same block as identical. Therefore “01234” and “56789” are the same.

KEY	P0	P1	P2	P3	▼ / ▲
NUMBER	0	1	2	3	4
	5	6	7	8	9

- ③ When the “PASSWORD” indication does not clear after inputting 4 digits, the input code number may be incorrect. Turn the power off and start over in this case.

■ Channel selection

Several types of channel selections are available. Methods may differ according to your system set up.

NON-BANK TYPE:

Push [▼]/[▲] to select the desired operating channel, in sequence; or, push one of the [MR-CH 1] to [MR-CH 4] keys to select a channel directly.

BANK-TYPE:

Push [Bank], then push [▼] or [▲] to select the desired bank.

AUTOMATIC SCAN TYPE:

Channel setting is not necessary for this type. When turning the power ON, the transceiver automatically starts scanning. Scanning stops when receiving a call.

■ Call procedure

When your system employs tone signalling (excluding CTCSS and DTCS), the call procedure may be necessary prior to voice transmission. The tone signalling employed may be a selective calling system which allows you to call specific station(s) only and prevent unwanted stations from contacting you.

- ① Select the desired TX code channel or 5-tone code according to your System Operator's instructions.
 - This may not be necessary depending on programming.
 - Refer to pgs. 16, 17 for selection.
- ② Push the call switch (assigned to one of the dealer programmable switches: [P0], [P1], [P2], [P3], [Red], [▼] and [▲]).
- ③ After transmitting a 5-tone code, the remainder of your communication can be carried out in the normal fashion.

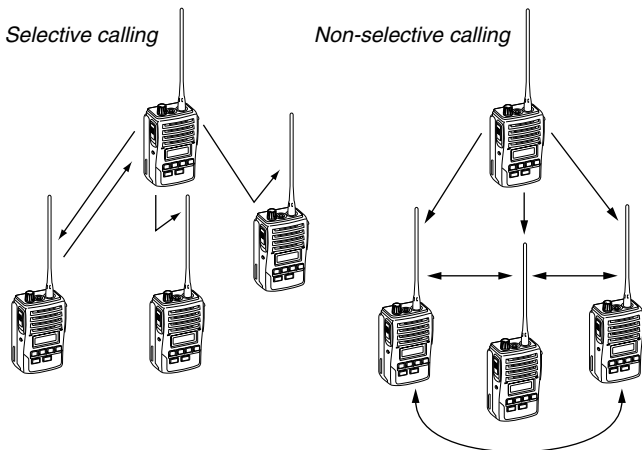

■ Receiving and transmitting

NOTE: Transmitting without an antenna may damage the transmitter. See p. 1 for antenna attachment.

3

Receiving:

- ① Rotate [VOL] to turn power ON.
- ② Push [▼] or [▲] to select a channel.
- ③ When receiving a call, adjust the audio output level to a comfortable listening level.

Transmitting:

Wait for the channel to become clear to avoid interference.

- ① While pushing and holding [PTT], speak into the microphone at a normal voice level.
 - When a tone signalling system is used, the call procedure described at left may be necessary.
- ② Release [PTT] to return to receive.

IMPORTANT: To maximize the readability of your signal;

1. Pause briefly after pushing [PTT].
2. Hold the microphone 5 to 10 cm from your mouth, then speak into the microphone at a normal voice level.

◇ Transmitting notes

• Transmit inhibit function

The transceiver has several inhibit functions which restrict transmission under the following conditions:

- The channel is in mute condition ('Inaudible' condition; "🔇" does not appear).
- Channel is busy.
- Un-matched (or matched) CTCSS is received.
- The selected channel is a 'receive only' channel.

• Time-out timer

After continuous transmission for the pre-programmed time period, the time-out timer is activated, causing the transceiver to stop transmitting.

• Penalty timer

Once the time-out timer is activated, transmission is further inhibited for a period determined by the penalty timer.

◇ TX code channel selection

If the transceiver has [TX Code CH Select] assigned to it, indication can be toggled between the operating channel number (or name) and TX code channel number (or name). When the TX code channel number (or name) is displayed, the [▼]/[▲] key selects the TX code channel.

TO SELECT A TX CHANNEL:

- ① Push [TX Code CH Select]— a TX code channel appears.
- ② Push [▼]/[▲] to select the desired TX code channel.
- ③ Push [Call] (or [PTT] during MSK operation) to transmit the selected TX code.
- ④ Push [TX Code CH Select] again to return to the operating channel number indication.

FOR TX CODE CHANNEL TYPE:

If the transceiver has a [TX Code CH Up] or [TX Code CH Down] key assignment, the programmed TX code channel can be selected directly.

◇ TX code number edit

If the transceiver has [TX Code CH Select] or [TX Code Enter] assigned to it, TX code contents can be edited within the allowable digits.

3

TO EDIT A TX CODE VIA [TX CODE CH SELECT] KEY:

- ① Push [TX Code CH Select] to enter the TX code channel selection mode.
 - Select the desired channel using [▼]/[▲] if necessary.
- ② Push [TX Code CH Select] for 1 sec. to enter the TX code edit mode.
- ③ Push [TX Code CH Select] to select the desired digit to be edited.
- ④ Set the desired digit using [▼]/[▲]/[TX Code CH Up]/[TX Code CH Down].
- ⑤ Push [TX Code CH Select] to set the digit. The editable digit will move to the right automatically.
- ⑥ Repeat ④ and ⑤ to input all allowable digits.
- ⑦ Push [Call] or [PTT] to transmit the selected TX code.

TO EDIT A TX CODE VIA [TX CODE ENTER] KEY:

- ① Select the desired TX code channel via [TX Code CH Up]/[TX Code CH Down].
- ② Push [TX Code Enter] to enter the TX code edit mode.
- ③ Push [TX Code Enter] to select the desired digit to be edited.
- ④ Set the desired digit using [▼]/[▲]/[TX Code CH Up]/[TX Code CH Down].
- ⑤ Push [TX Code Enter] to set the digit. The editable digit will move to the right automatically.
- ⑥ Repeat ④ and ⑤ to input all allowable digits.
- ⑦ Push [Call] or [PTT] to transmit the selected TX code.

3 CONVENTIONAL OPERATION

◇ DTMF transmission

If the transceiver has [DTMF Autodial] assigned to it, the automatic DTMF transmission function is available. Up to 8 DTMF channels are available.

TO SELECT A TX CODE:

- ① Push [DTMF Autodial]— a DTMF channel appears.
- ② Push [▼]/[▲] to select the desired DTMF channel.
- ③ Push [DTMF Autodial] to transmit the DTMF code in the selected DTMF channel.

■ Scrambler function

The voice scrambler function provides private communication between stations. The frequency inversion type is equipped to all versions, and some versions have the Rolling or Non-rolling type installed.

- ① Push [Scrambler] to turn the scrambler function ON.
- ② “**3**” appears.
- ③ Push [Scrambler] again to turn the scrambler function OFF.

■ User set mode

User set mode is accessed at power ON and allows you to set seldom-changed settings. In this case you can “customize” transceiver operation to suit your preferences and operating style.

3

Entering the user set mode:

- ① While pushing and holding [▼] and [▲], rotate [VOL] to enter the user set mode at power ON.
- ② Push and hold [P0] to enter user set mode. Push [P0] momentarily to select the item.
Then push [▼] and [▲] to set the desired level/condition.

Available set mode functions:

- Backlight : ON, Auto or OFF
- Beep : ON or OFF
- SQL Level : 0 to 255
- AF Min level : ON or OFF
- Mic Gain : 1 to 5
- Battery Voltage : ON or OFF

- ③ Push and hold [P0] again to exit set mode.

User set mode is also available using a programmable key. Please refer to p. 12 “User Set Mode” section.

4 BIIS OPERATION



■ Default setting

The following functions are assigned to each programmable key as the default. Ask your dealer for details.

- [P0]; Call : Push to transmit a 5-tone/BIIS call when the selected channel is a 5-tone or MSK channel, respectively.
- [P1]; Digital : Push to select the call list ID/transmit message, or to display the receive message record for selection.
- [P3]; Moni(Audi) : Push this key after the communication to send a "clear down" signal during MSK channel operation.
- [▼]/[▲]; CH Down/Up : While in the standby condition, selects the operating channel.
After pushing [Digital] or [TX Code CH Select], push to select the call list or TX code channel, respectively.
- [P2]/[Red]; Null : No function is assigned.

■ Receiving a call

◇ Individual call

- ① When an individual call is received;
 - Beeps sound.
 - “” appears and the mute is released.
 - The programmed text message (e.g. “CALLING”) and the calling station ID (or text) is displayed alternately, depending on the setting.
 - “” appears or blinks depending on the setting.

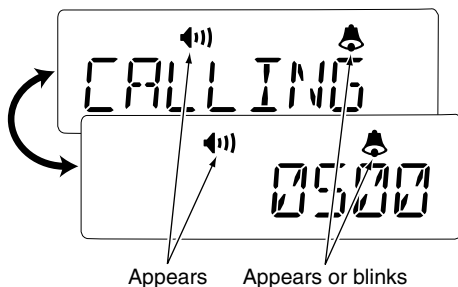

- ② Push and hold [PTT], then speak into the microphone at a normal voice level.
 - Transmit/Busy indicator lights red.
- ③ Release [PTT] to return to receive.
 - Transmit/Busy indicator lights green while receiving a signal.
- ④ To finish the conversation, push [P3] (Moni(Audi)) to send the “Clear down” signal.
 - Either station can send a clear down signal.
 - “CLR DOWN” is displayed for 2 sec. (approx.).
 - “” disappears and the transceiver returns to the standby condition.

4 BIIS OPERATION

◇ Group call

- ① When a group call is received;
 - Beeps sound.
 - “

Appears Appears or blinks

- ② Push and hold [PTT], then speak into the microphone at a normal voice level.
 - ⚡ **NOTE:** Only one station is permitted to speak.
 - Transmit/Busy indicator lights red.
- ③ Release [PTT] to return to receive.
 - Transmit/Busy indicator lights green while receiving a signal.
- ④ To finish the conversation, push [P3] (Moni(Audi)) to send the “Clear down” signal.
 - Either station can send a clear down signal.
 - “CLR DOWN” is displayed for 2 sec. (approx.)
 - “

22

◇ Displaying the received call record — Queue indication

The transceiver memorizes the calling station IDs for record. Up to 3 calls can be memorized, and the oldest call record is erased when a 4th call is received. However, once the transceiver is powered OFF, the all records are cleared.

4

- ① Push [P1] (Digital) for 1 sec.
 - Displays following indication.

When a record is available

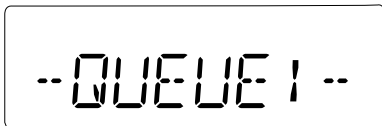

When no record is available

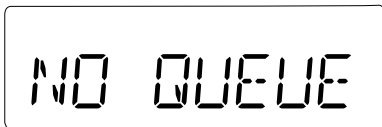

- ② Push [▼]/[▲] to select the desired call.
- ③ Push [P1] (Digital) for 1 sec. again to return to the standby condition.
 - When no operation is performed for 30 sec., the transceiver returns to the standby condition automatically.

■ Transmitting a call

Total of a 3 ways for code selection are available—selecting the call code from memory, entering the call code from the keypad and calling back from the queue channel record.

◇ Using call memory

- ① While in the standby condition, push [P1] (Digital) to enter the call code memory channel selection mode.

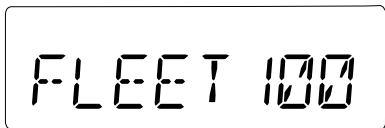

Call code text is displayed.

- ② Push [▼]/[▲] to select the desired call code.
- ③ Push [P0] (Call) or [PTT]* to call.
*PTT call can be made only when PTT call capability is permitted.

NOTE: When no answer back is received, the transceiver repeats the call 3 times (default) automatically, and “WAIT” is displayed during each call. However, an error beep sounds and “FRILED” is displayed when no answer back is received after the calls.

- ④ Push [PTT] to transmit; release to receive.
- ⑤ Push [P3] (Moni(Audi)) to send the “Clear down” signal.

◇ Calling back from the queue channel

- ① While in the standby condition, push [P1] (Digital) for 1 sec. to enter queue memory channel selection mode.
- ② Push [▼]/[▲] to select the desired record.

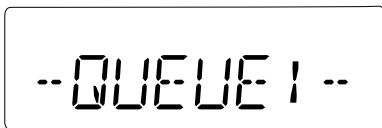

- ③ Push [P0] (Call) or [PTT]* to call.

*PTT call can be made only when PTT call capability is permitted.

NOTE: When no answer back is received, the transceiver repeats the call 3 times (default) automatically, and "WAIT" is displayed during each call. However, an error beep sounds and "FAILED" is displayed when no answer back is received after the calls.

- ④ Push [PTT] to transmit; release to receive.
- ⑤ Push [P3] (Moni(Audi)) to send the "Clear down" signal.

4 BIIS OPERATION

◆ Direct code entry

- ① While in the standby condition, push [TX Code Enter] to enter the TX code edit mode.
 - Editable code digit blinks.



- ② Push [TX Code Enter] to select the desired digit to be edited.
 - Editable digit differs according to the setting.
- ③ Set the desired digit using [▼]/[▲]/[TX Code CH Up]/[TX Code CH Down].
- ④ Push [TX Code Enter] to set the digit. The editable digit will move to the right automatically.
- ⑤ Repeat ③ and ④ to input all allowable digits.
- ⑥ Push [P0] (Call) or [PTT]* to call.
 - *PTT call can be made only when PTT call capability is permitted.

NOTE: When no answer back is received, the transceiver repeats the call 3 times (default) automatically, and “WAIT” is displayed during each call. However, an error beep sounds and “FAILED” is displayed when no answer back is received after the calls.

- ⑦ Push [PTT] to transmit; release to receive.
- ⑧ Push [P3] (Moni(Audi)) to send the “Clear down” signal.

For your information

When the “UpDate” setting for the call code is enabled, the set code is overwritten into the call code memory.

■ Receiving a message

◇ Receiving a status message

- ① When a status message is received;
- Beeps sound.
 - The calling station ID (or text) and the status message is displayed alternately, depending on the setting.

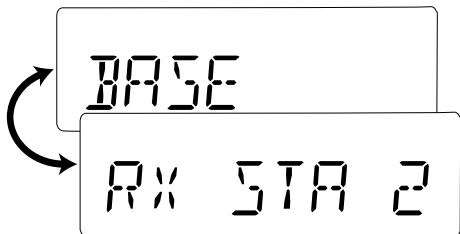

- ② Push [P3] (Moni(Audi)) to return to the standby condition.

NOTE: Only the calling station ID (or text) is displayed (no message is displayed alternately) when the scroll timer is set to "OFF". In this case, push [Status Up]/[Status Down] to display the status message manually.

4 BIIS OPERATION

◆ Receiving an SDM

- ① When an SDM is received;
 - Beeps sound.
 - The calling station ID (or text) and the SDM is displayed alternately, depending on the setting.

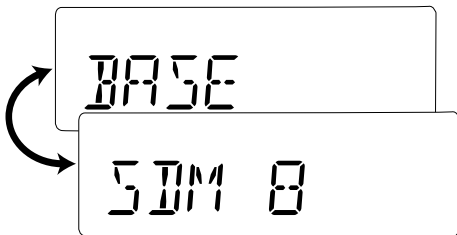

- ② When the received SDM includes more than 8 characters, the message scrolls automatically, when the automatic scroll function is activated.
 - Push [Status Up]/[Status Down] to scroll the message manually.
- ③ Push [P3] (Moni(Audi)) to return to the standby condition.

◇ Received message selection

The transceiver memorizes the received messages for record. Up to 6 messages for status and SDM, or 95 character SDM's can be memorized. The oldest message is erased when the 7th message is received. However, once the transceiver is powered OFF, all messages are cleared.

- ① Push [P1] (Digital) for 1 sec.
 - Displays queue memory.
- ② Push [P1] (Digital) momentarily.
 - Displays message memory.

When a message is available

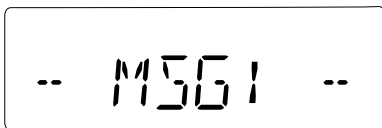

When no message is available

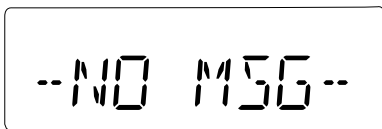

- ③ Push [▼]/[▲] to select the desired message.
 - When selecting the SDM that includes more than 8 characters, the message scrolls automatically, when the automatic scroll function is activated.
 - Push [Status Up]/[Status Down] to scroll the message manually.
- ④ Push [P1] (Digital) for 1 sec. again to return to the standby condition.
 - When no operation is performed for 30 sec., the transceiver returns to the standby condition automatically.

■ Transmitting a status

◇ General

The status message can be selected with the programmed text, and the message text is also displayed on the function display of the called station.

Up to 24 status types (1 to 24) are available, and the status messages 22 and 24 have designated meanings.

Status 22: Emergency*

Status 24: GPS request

*The status 22 can also be used as a normal status message by disabling the designated meaning. However, the status 24 is fixed.

The status call can be sent with both individual and group calls.

◇ Transmitting a status

- ① While in the standby condition, push [P1] (Digital), then push [▼]/[▲] to select the desired station/group code.
- ② Push [P1] (Digital) again, then push [▼]/[▲] to select the desired status message.

Or, you can select the desired status message using [Status Up]/[Status Down] key directly.

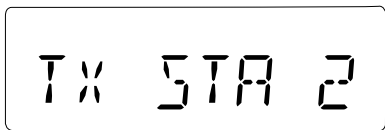

Status message is displayed.

- ③ Push [P0] (Call) or [PTT]* to transmit the status message to the selected station/group.
 - *PTT call can be made only when PTT call capability is permitted.
 - 2 beeps will sound and the transceiver returns to the standby condition automatically when the transmission is successful.

■ Transmitting an SDM

◇ General

The short data message, SDM, can be sent to an individual station or group stations. Also, 8 SDM memory channels are available and the messages can be edited via PC programming.

4

◇ Transmitting an SDM

- ① While in the standby condition, push [P1] (Digital), then push [▼]/[▲] to select the desired station/group code.
- ② Push [P1] (Digital) again, then push [▼]/[▲] to select the desired SDM.

Or, you can select the desired SDM using [Status Up]/[Status Down] key directly.

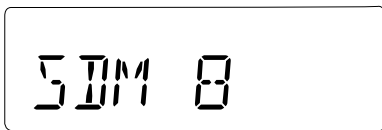

SDM is displayed.

- ③ Push [P0] (Call) or [PTT]* to transmit the SDM to the selected station/group.
 - *PTT call can be made only when PTT call capability is permitted.
 - 2 beeps will sound and the transceiver returns to the standby condition automatically when the transmission is successful.

■ Position data transmission

When the optional OPC-966 INTERFACE CABLE and a GPS receiver is connected to the transceiver, the position (longitude and latitude) data can be transmitted automatically.

Ask your dealer or system operator for connection details.

The position data is transmitted when;

- Status 24 message is received
 - *When the status 24 message, GPS request, is received.
- Fully automatic
 - When automatic position transmission is enabled, send the position data according to 'Time Marker' and 'Interval Timer' settings.
- PTT is released
 - When 'Send with Logoff' is enabled.
 - Set the "Log-In/Off" item as "L-OFF".
- After sending a status message
 - When 'Send with Status' is enabled.
- After sending an SDM
 - When 'Send with SDM' is enabled.
- After sending status 22 (Emergency)
 - When 'Send with Emergency' is enabled.

■ Printer connection

When the optional OPC-966 INTERFACE CABLE is connected to the transceiver, a printer can be connected to print out the received SDM content and the ID of the station who sent the message.

Ask your dealer or system operator for connection details.

4

■ PC connection

When the optional OPC-966 INTERFACE CABLE is connected to the transceiver, a PC can be connected to provide remote control, data reception, etc.

Ask your dealer or system operator for connection details.

■ Digital ANI

The own ID can be transmitted each time the PTT is pushed (log-in) or released (log-off) during individual or group call communications. By receiving the ANI, the communication log can be recorded when using a PC dispatch application.

In addition, when using the ANI with log-in, the PTT side tone function can be used to inform you that the ID is sent and voice communication can be performed.

■ Auto emergency transmission

When [Emergency Single (Silent)] or [Emergency Repeat (Silent)] is pushed, an emergency signal is automatically transmitted for the specified time period.

The status 22 (Emergency) is sent to the selected ID station, and the position data is transmitted after the emergency signal when a GPS receiver is connected to the transceiver.

The emergency transmission is performed on the emergency channel, however, when no emergency channel is specified, the signal is transmitted on the previously selected channel.

There is no change in the function display or beep emission during automatic emergency transmission.

■ Stun function

When the specified ID, set as a killer ID, is received, the stun function is activated.

When the killer ID is received, the transceiver switches to the passcode required condition. Entering of the passcode via the keypad is necessary to operate the transceiver again in this case.

■ BIIS indication

The following indications are available for the BIIS operation on an MSK channel.

- CONNECT* : Individual/group call is successful.
- OK* : Message (status or SDM) transmission is successful.
- FAILED* : No answer back is received.
- WAIT* : Appears during retry of the call (2nd call).
- CLR DOWN* : End the communication.
- BUSY* : Operating channel is in the busy condition.

4

■ Priority A channel selection

When one of the following operations is performed, the transceiver selects the Priority A channel automatically.

Priority A is selected when;

- Clear down signal is received/transmitted
 - Set the "Move to PrioA CH" item as "Clear Down".
- Turning the power ON
 - The Priority A channel is selected each time the transceiver power is turned ON.
- Status call
 - The Priority A channel is selected when transmitting a status call.
 - Enable the "Send Status on PrioA CH" item in the MSK configuration.

5 BATTERY CHARGING

■ Battery charging

Prior to using the transceiver for the first time, the battery pack must be fully charged for optimum life and operation.

 **WARNING! NEVER** charge the battery (with/without the transceiver) in an explosive atmosphere. The optional battery chargers are not approved as Intrinsically Safe.

 **CAUTION!** To avoid damage to the transceiver, turn it OFF while charging.

- Recommended temperature range for charging:
0°C to +45°C
 - The Li-Ion battery functions within -10°C to +60°C
- Use the specified chargers (BC-152, BC-119N and BC-121N). **NEVER** use another manufacturer's charger.
- Use the optional AC adapter (BC-147E) for the BC-152.
- **NEVER** use another manufacturer's AC adapter.

Recommendation:

Charge the supplied battery pack for a maximum of up to 10 hours. Li-Ion batteries are different from Ni-Cd batteries in that it is not necessary to completely charge and discharge them to prolong the battery life. Therefore, charging the battery in intervals, and not for extended periods is recommended.

■ Caution

⚠ **WARNING! NEVER** release or attach the battery pack in an explosive atmosphere. This may pose a fire hazard and result in an explosion.

CAUTION! NEVER release or attach the battery pack when the transceiver is wet or soiled. This may result in water or dust getting into the transceiver/battery pack and may damage the transceiver.

NEVER incinerate used battery packs. Internal battery gas may cause an explosion.

NEVER immerse the battery pack in water. If the battery pack becomes wet, be sure to wipe it dry immediately (particularly the battery terminals) BEFORE attaching it to the transceiver. Otherwise, the terminals will become corroded, or cause connection failure, etc.

NEVER short the terminals of the battery pack. Also, current may flow into nearby metal objects, such as a necklace, etc. Therefore, be careful when carrying with, or placing near metal objects, carrying in handbags, etc.

DO NOT leave the battery pack in a fully charged, or completely discharged condition for long time. It causes shorter battery life. In case of leaving the battery pack unused for a long time, it must be kept safely after discharge, or use the battery until the battery indicator appears, then remove it from the transceiver.

If your battery pack seems to have no capacity even after being charged, fully charge the battery pack again. If the battery pack still does not retain a charge (or very little), a new battery pack must be purchased.

■ Optional battery chargers

◆ Regular charging with the BC-152

- ① Attach the BC-152 to a flat surface, such as a desk, if desired.
- ② Connect the AC adapter (BC-147E) as shown below.
- ③ Insert the battery pack with/without the transceiver into the charger.
 - The charge indicator lights green.
- ④ Charge the battery pack approx. 9–10 hours, depending on the remaining power condition.
 - The charge indicator goes off when charging is complete.

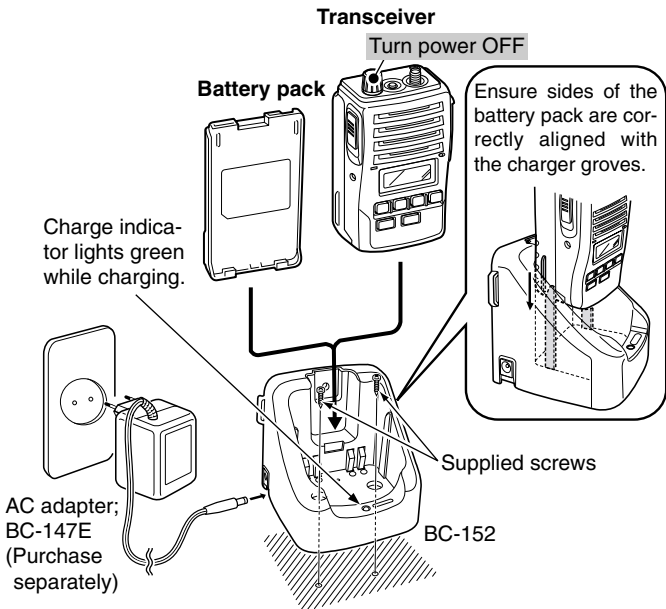

◇ For your convenience

Eyelet →
USE a rubber band to
secure the transceiver
while charging, if
desired.

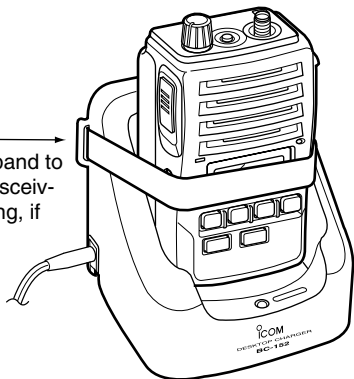

5 BATTERY CHARGING

◇ AD-100 installation

The AD-100 CHARGER ADAPTER must be installed into the BC-119N or BC-121N before battery charging.

- ➔ Connect the AD-100 CHARGER ADAPTER and the BC-119N/BC-121N as below, then install the AD-100 into the holder space of the BC-119N or BC-121N with the supplied screws.

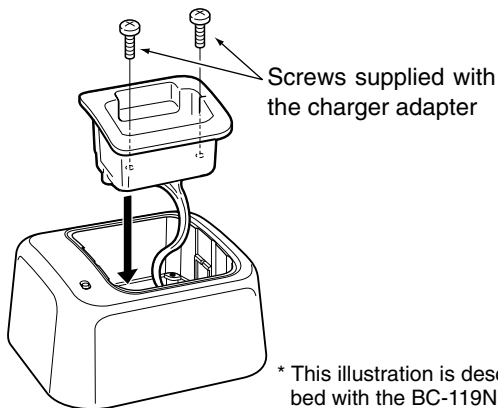
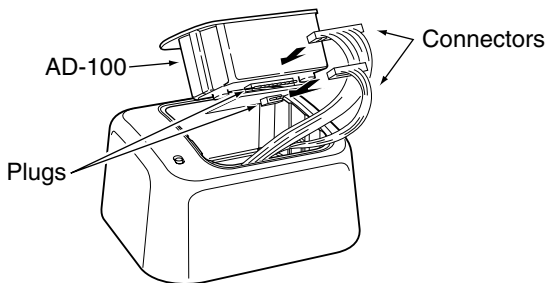

◇ Rapid charging with the BC-119N+AD-100

The optional BC-119N provides rapid charging of Li-Ion battery pack.

The following are additionally required:

- One AD-100 (purchase separately)
- An AC adapter (may be supplied with BC-119N depending on version) or the DC power cable (OPC-515L/CP-17L).

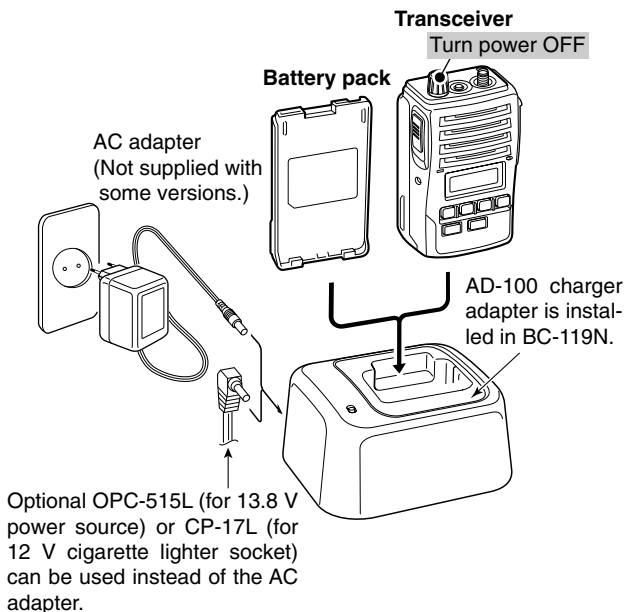

5 BATTERY CHARGING

◇ Rapid charging with the BC-121N+AD-100

The optional BC-121N allows up to 6 battery packs to be charged simultaneously. The following are additionally required.

- Six AD-100 (purchase separately)
- An AC adapter (BC-157) or the DC power cable (OPC-656)

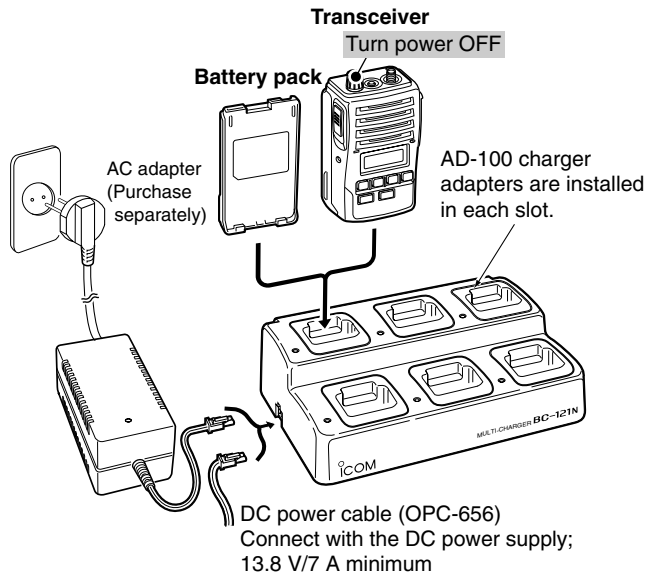

SPEAKER-MICROPHONE

6

■ Optional HM-138 description

Alligator type clip

To attach the speaker-mic.
to your shirt or collar, etc.

PTT switch

Transmits while pushed
Receives while released

Microphone

Speaker

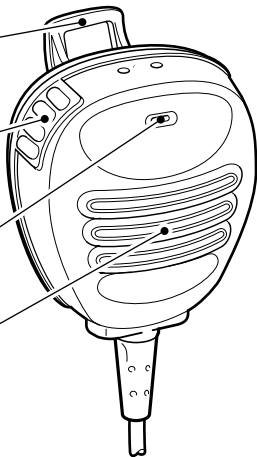

5

6

NEVER immerse the connector in water. If the connector becomes wet, be sure to dry it **BEFORE** attaching it to the transceiver.

NOTE: The microphone is located at the top of the speaker-microphone, as shown in the diagram above. To maximize the readability of your transmitted signal (voice), hold the microphone approx. 5 to 10 cm from your mouth, and speak in a normal voice level.

■ Attachment

Attach the connector of the speaker-microphone into the [SP MIC] connector on the transceiver and tighten the screw.

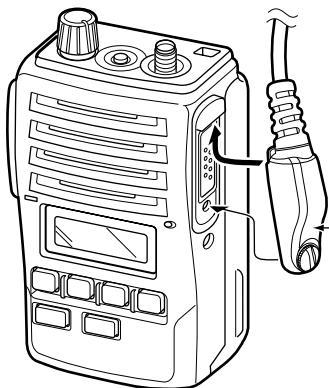

CAUTION: Attach the speaker-microphone's connector securely to prevent accidental dropping, or water intrusion in the connector.

IMPORTANT: KEEP the [SP MIC] jack cover attached (transceiver) when the speaker-microphone is not in use. Water will not get into the transceiver even if the cover is not attached, however, the terminals (pins) will become rusty, or the transceiver will function abnormally if the connector becomes wet.

CAUTION: For ATEX compliance in hazardous areas, the jack cover just also be attached when the HM-138 is not being used.

OPTIONS 7

- **BP-227AX** Li-Ion BATTERY PACK
7.2 V/1700 mAh Li-Ion battery pack. The same as supplied with the transceiver. BP-227AX must be charged with the optional BC-152 or the BC-119N/121N.
- **BC-152** DESKTOP CHARGER + **BC-147E** AC ADAPTER
Used for regular charging of the battery pack. The AC adapter, BC-147E, must be purchased separately.
Charging time: approx. 9–10 hours
- **BC-119N** DESKTOP CHARGER + **AD-100** CHARGER ADAPTER + **BC-145** AC ADAPTER
For rapid charging of battery packs. An AC adapter is not supplied with some versions.
Charging time: approx. 2 to 2.5 hours
- **BC-121N** MULTI-CHARGER + **AD-100** CHARGER ADAPTER (6 pcs.) + **BC-157** AC ADAPTER
For rapid charging of up to 6 battery packs (six AD-100's are required) simultaneously. An AC adapter should be purchased separately.
Charging time: approx. 2 to 2.5 hours
- **HM-138** SPEAKER-MICROPHONE
Full-sized waterproof (JIS grade 7; 1m/30 min.) speaker-microphone including alligator type clip to attach to your shirt or collar, etc.
- **MB-98** BELT CLIP
- **MB-86** SWIVEL BELT CLIP
- **MB-96F** LEATHER BELT HANGER
- **FA-S62VS/FA-S63VS/FA-S57US** STUBBY ANTENNA
FA-S62VS: 150–162 MHz FA-S63VS: 160–174 MHz
FA-S57US: 450–490 MHz

8 ATEX CAUTIONS

◇ Special conditions for safe use

The equipment is an intrinsically safe equipment. It can be used in a potentially explosive atmosphere.

The equipment must be powered only by the battery Icom type BP-227AX.

When the transceiver is used in a hazardous areas, either the jack cover or HM-138 must be attached to the connector. Failure to do this will make the radio ATEX non-compliant and may result in an accident during use in hazardous areas.

The battery shall be charged only in non hazardous areas.

The battery shall be changed only in non hazardous areas.

Ambient operating temperature: -20°C to +55°C

◇ Meaning of ATEX marking codes

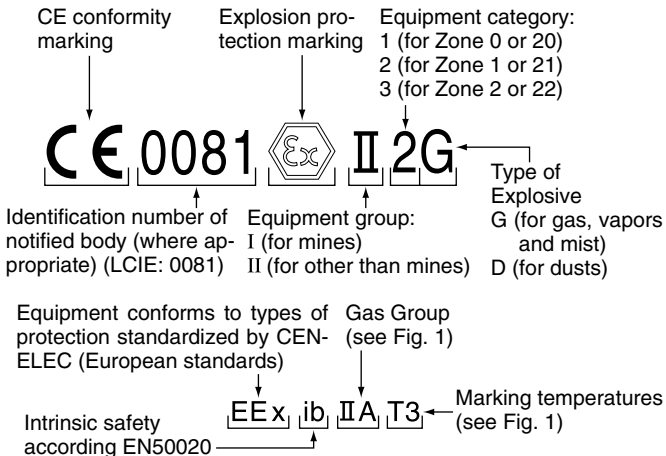

Gas Group	Max. Temperature						
	T1: 450°C	T2: 300°C	T3: 200°C	T4: 135°C	T5: 100°C	T6: 85°C	
I	Methane	—	—	—	—	—	
	Acetone	Ethyl alcohol	Benzine	Acetalde hyde	—	—	
IIA	Ethane	i-amyl acetate	Diesel fuel	Ethyl ether	—	—	
	Ethyl acetate	n-butane	Aircraft fuel	—	—	—	
	Ammonia	n-butyl alcohol	Heating oil	—	—	—	
	Benzene (pure)	—	n-hexane	—	—	—	
	Acetic acid	—	—	—	—	—	
	Carbon Monoxide	—	—	—	—	—	
	Methanol	—	—	—	—	—	
	Propane	—	—	—	—	—	
	Toluene	—	—	—	—	—	
	Town Gas (Coal Gas)	Ethylene	—	—	—	—	
IIC	Hydrogen	Acetylene	—	—	Carbon disulphide	Ethyl nitrate	

(Fig. 1)

9 DOC

The following explanations are about the symbols on the attached Declaration of Conformity.



CE versions of the IC-F51/F61 which display the “CE” symbol on the serial number seal, comply with the essential requirements of the European Radio and Telecommunication Terminal Directive 1999/5/EC and ATEX Directive 94/9/EC.



This warning symbol indicates that this equipment operates in non-harmonised frequency bands and/or may be subject to licensing conditions in the country of use. Be sure to check that you have the correct version of this radio or the correct programming of this radio, to comply with national licensing requirement.

Count on us!

< Intended Country of Use >

- | | | | |
|------------------------------|------------------------------|------------------------------|------------------------------|
| <input type="checkbox"/> GER | <input type="checkbox"/> FRA | <input type="checkbox"/> ESP | <input type="checkbox"/> SWE |
| <input type="checkbox"/> AUT | <input type="checkbox"/> NED | <input type="checkbox"/> POR | <input type="checkbox"/> DEN |
| <input type="checkbox"/> GBR | <input type="checkbox"/> BEL | <input type="checkbox"/> ITA | <input type="checkbox"/> FIN |
| <input type="checkbox"/> IRL | <input type="checkbox"/> LUX | <input type="checkbox"/> GRE | <input type="checkbox"/> SUI |
| <input type="checkbox"/> NOR | | | |

A-6365H-1EU-⑦

Printed in Japan

© 2005–2008 Icom Inc.

Printed on recycled paper with soy ink.

Icom Inc.

1-1-32 Kamiminami, Hirano-ku, Osaka 547-0003, Japan